

PHONIC

Sound Ambassador 75 Sound Ambassador 120

Mobile PA System

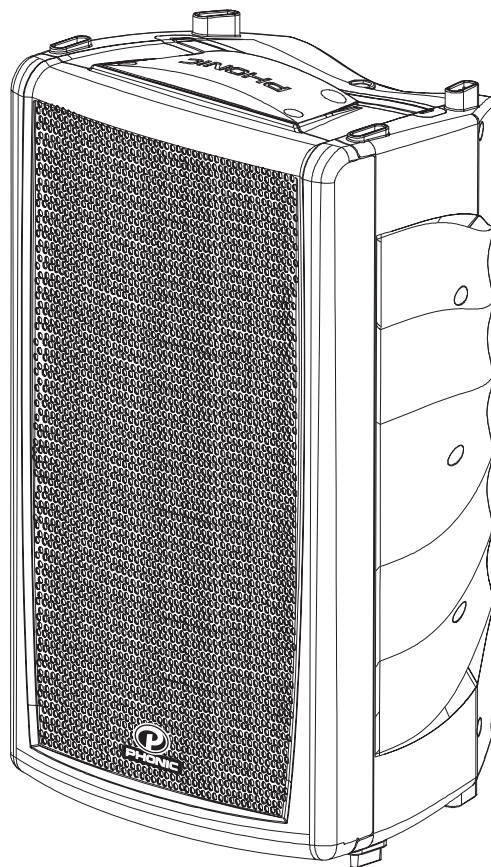

Sound Ambassador 120

English

User's Manual

IMPORTANT SAFETY INSTRUCTIONS

The apparatus shall not be exposed to dripping or splashing and that no objects filled with liquids, such as vases, shall be placed on the apparatus. The MAINS plug is used as the disconnect device, the disconnect device shall remain readily operable.

Warning: the user shall not place this apparatus in the confined area during the operation so that the mains switch can be easily accessible.

1. Read these instructions before operating this apparatus.
2. Keep these instructions for future reference.
3. Heed all warnings to ensure safe operation.
4. Follow all instructions provided in this document.
5. Do not use this apparatus near water or in locations where condensation may occur.
6. Clean only with dry cloth. Do not use aerosol or liquid cleaners. Unplug this apparatus before cleaning.
7. Do not block any of the ventilation openings. Install in accordance with the manufacturer's instructions.
8. Do not install near any heat sources such as radiators, heat registers, stoves, or other apparatus (including amplifiers) that produce heat.
9. Do not defeat the safety purpose of the polarized or grounding-type plug. A polarized plug has two blades with one wider than the other. A grounding type plug has two blades and a third grounding prong. The wide blade or the third prong is provided for your safety. If the provided plug does not fit into your outlet, consult an electrician for replacement of the obsolete outlet.
10. Protect the power cord from being walked on or pinched particularly at plug, convenience receptacles, and the point where they exit from the apparatus.
11. Only use attachments/accessories specified by the manufacturer.
12. Use only with a cart, stand, tripod, bracket, or table specified by the manufacturer, or sold with the apparatus. When a cart is used, use caution when moving the cart/apparatus combination to avoid injury from tip-over.
13. Unplug this apparatus during lightning storms or when unused for long periods of time.
14. Refer all servicing to qualified service personnel. Servicing is required when the apparatus has been damaged in any way, such as power-supply cord or plug is damaged, liquid has been spilled or objects have fallen into the apparatus, the apparatus has been exposed to rain or moisture, does not operate normally, or has been dropped.

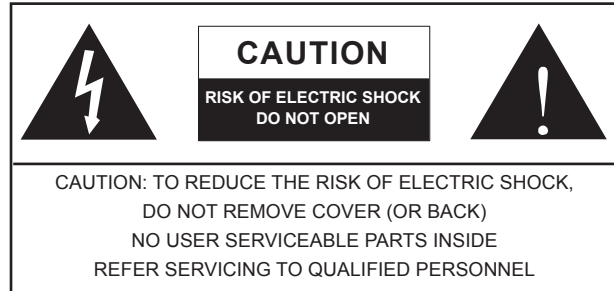

The lightning flash with arrowhead symbol, within an equilateral triangle, is intended to alert the user to the presence of uninsulated "dangerous voltage" within the product's enclosure that may be of sufficient magnitude to constitute a risk of electric shock to persons.



The exclamation point within an equilateral triangle is intended to alert the user to the presence of important operating and maintenance (servicing) instructions in the literature accompanying the appliance.

WARNING: To reduce the risk of fire or electric shock, do not expose this apparatus to rain or moisture.

CAUTION: Use of controls or adjustments or performance of procedures other than those specified may result in hazardous radiation exposure.



Sound Ambassador 75/120

Mobile PA System

USER'S MANUAL

TABLE OF CONTENTS

INTRODUCTION.....	4
FEATURES.....	4
BASIC SETUP.....	4
OPTIONAL ACCESSORY.....	4
CONNECTIONS AND SETTINGS.....	5
APPLICATION.....	7
SPECIFICATIONS.....	8
DIMENSIONS.....	9

Introduction

We at Phonic would like to congratulate you on your purchase of our Sound Ambassador 75 or 120 fully integrated mobile sound system. This extremely stylish system will allow you to carry all the gear you need to set up a moderate front of house sound system anywhere you go without lugging around chunky mixers, speakers and cords.

Including various input channels, with microphone and line inputs, as well as stereo RCA inputs, the Sound Ambassador provides just enough room for a small band, choir or DJ to give their audience crystal clear sound. The built-in amplifier pumps 75 or 120 Watts of power through the 1" tweeter and 10" woofer – all of which is built right into the cabinet!

This owner's manual was designed to give you a clear picture of all the features and functions of the Sound Ambassador. It is strongly advised that you read this manual carefully before storing it in an easily accessible in case it is needed for future reference.

Features

- Completely integrated mixer, amp and speaker mobile sound unit
- Completely flexible configuration (tripod, stackable, wall-mountable)
- Able to operate on DC power with optional Battery Pack
- Switching power supply (AC 100~120V/200~240V, 50/60Hz, two-band switch)
- Each independent channel features a 2-band (high-low) equalizer
- Channel 4 features RCA inputs allowing connection of CD or tape players
- 2-way speaker (10" woofer, 1" tweeter) built right into the mixer
- Power amplifier provides speaker with 75 or 120 Watt of power at 8 ohms
- Complete amplifier thermal and peak protection
- Sturdy plastic enclosure for complete durability

Basic Setup

1. Ensure all power is turned off on the Sound Ambassador. To totally ensure this, the AC cable should not be connected to the unit.
2. All level controls should be set at the lowest level to ensure no sound is inadvertently sent through the outputs when the device is switched on. All levels can be adjusted to acceptable degrees after the device is turned on.
3. Plug all necessary instruments and/or equipment into the Sound Ambassador's various inputs as required. This may include devices such as microphones, electric guitars, keyboards, etc.
4. Though it is not required (as the Sound Ambassador's speaker is built-in), you may wish to connect various devices to the Sound Ambassador's outputs, which could further enhance your set up.
5. Plug the supplied AC cable into the AC inlet on the back of the device, ensuring the local voltage level is identical to that set by the voltage selection switch on your device. Plug the other end into an AC power outlet.
6. Turn the power switch on, and you should be ready to go.

Optional Accessory

- UM 30: Wireless Handheld System
- UM 40: Wireless System with Lavalier Mic
- UM 50: Wireless System with Headset Mic
- MK3-SA: wall/ceiling mounting kit
- CV-RG: 12V to 48V DC-DC power converter for Sound Ambassador 120
- CV-RG36: 12V to 36V DC-DC power converter for Sound Ambassador 75
- BP-RG: 22Ah Lead-acid battery Pack

When using external battery to offer power to the Sound Ambassador, it is necessary to work with DC-DC power converter

Connections and Settings

1. Wireless Microphone Module Slot

These two slots are for the addition of wireless microphone modules to your Sound Ambassador. They allow users to use microphones from various locations without a cord getting in the way. For information on purchasing the wireless microphone kit, please contact your nearest Phonic dealer.

Please Note: The left wireless receiver slot will patch the microphone's signal to input channel 1, whereas the right slot will send the signal to input channel 2.

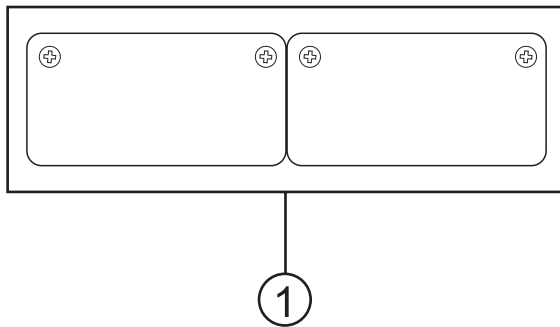

2. Level Control

The level controls on channels 1 through to 4 adjust the level of the audio that is received through the Line or Microphone inputs.

3. Treble Control

Located on channels 1 through to 3, the treble controls give a shelving boost of ± 15 dB to high frequency sounds (set at 12 kHz). This will adjust the amount of treble included in the audio of the channel, adding strength and crispness to sounds such as guitars, cymbals, and synthesizers.

4. Bass Control

These controls are used to give a shelving boost or cut of ± 15 dB to low frequency (80 Hz) sounds. This will adjust the amount of bass included in the audio of the channel, and bring more warmth and punch to drums and bass guitars.

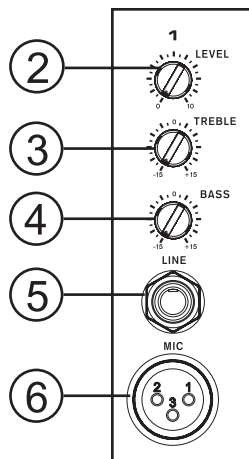

5. Line Input

These inputs accept typical 1/4" TRS or TS inputs, for balanced or unbalanced signals. They are best suited for input of electric guitars, bass guitars, synthesizers and drum machines, as well as other similar line-level instruments. When a device is plugged into the 1/4" input, the Microphone input will affectively be cut-off.

6. Microphone Input

These 3-pin XLR microphone jacks, found on channels 1 and 2, are for the addition of microphones to the Sound Ambassador. We recommend using professional balanced dynamic or ribbon mics as they are less likely to have interference and provide a good quality of sound.

7. Channel 3 Line Inputs

On Channel 3 of the Phonic Sound Ambassadors, you will find both 1/4" and XLR line inputs, suitable for various line-level devices such as synthesizers, keyboards, as well as other Sound Ambassador units.

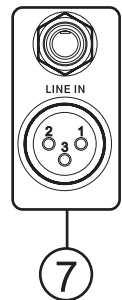

8. Stereo RCA Inputs

This stereo RCA input is for the addition of devices (such as CD and tape players) that use RCA outputs. The level of this input is controlled by the channel 4 level control.

9. Amplifier Input

Inserting a 1/4" plug into this jack will allow users to utilize the built-in power amplifier and speaker for the signal received through that connection. In this case, other signals received through channels 1 through to 4 are affectively cut off from the amplifier (however are still sent to the Link Out), and the new signal becomes the sole signal used by the Sound Ambassador's amp and speaker.

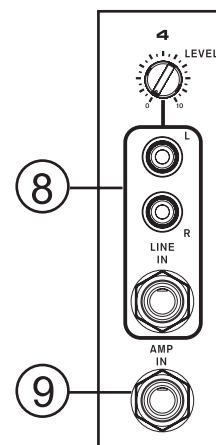

10. Clip LED

This small LED will light up slightly before overload occurs. Users are advised to adjust the main level so this LED does not light up when it operation. This will help in avoiding unwanted distortion in the audio.

11. Master Level Control

This control will allow users to adjust the final level of the signal sent to the built-in power amplifier and speakers. This will in no way affect the Link Out signal.

12. Link Out

These balanced XLR and 1/4" outputs send the main signal of the Sound Ambassador to external devices. Users are able to send the signal to other sound systems, allowing the signal to be incorporated in other mixes, or to an amplifier, allowing other speakers to output the signal in addition to the built-in speaker, as well as link to other Sound Ambassadors. These outputs are in no way affected by the master level control.

13. Speaker Output

This 1/4" TS output allows users to send the main signal of the Sound Ambassador to an external passive speaker. The impedance of the passive speaker should be no less than 8 ohms. When a speaker is connected to this output, the built-in speakers will run in parallel with the connected speaker.

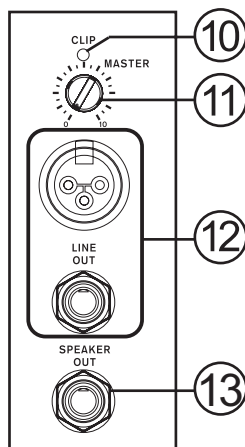

14. DC Power Input

When using the optional rechargeable Sound Ambassador battery pack and 12V DC-DC converter to connect to this DC power input, please ensure the rightmost socket is used for the positive 36VDC connection (48VDC on the Sound Ambassador 120), and the leftmost is used for the negative 36VDC connection (48VDC on the Sound Ambassador 120). The middle sockets are for grounds.

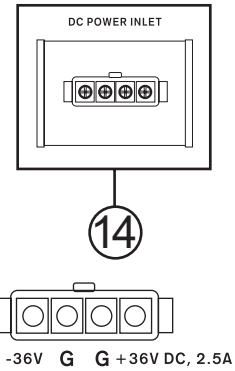

Warning: The power supply should not exceed 36V (48V on the Sound Ambassador 120) as to ensure the safe operation of this device. Also, do not plug in both DC and AC power supplies at the same time. When the DC power connection is used, the device automatically turns on, rendering the power button useless.

15. AC Power Inlet and Fuse Holder

This is for the addition of an AC power source to the Sound Ambassadors 75 and 120. Connect the provided power cable into this inlet, and the other end into a suitable AC power source. Ensure the voltage select switch is in the correct position for your Country's local voltage level. This power inlet also features a fuse holder. If the fuse blows, it must be replaced with another suitable fuse (as indicated on the fuse holder's cover). The Sound Ambassador will not operate on AC power if the fuse is damaged or missing.

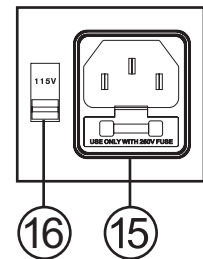

16. Voltage Select Switch

This switch allows users to adjust the Sound Ambassador to areas with differing voltage levels. For example, in the United States, the switch would be set to 115V, whereas in, say, England, it would be set to 230V. Users are advised to check local voltage levels before operating this unit.

17. Power Switch and Indicator

Flicking this switch turns the Sound Ambassador on and off. The blue power LED lights up when the power is on.

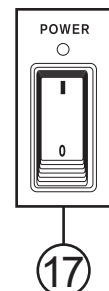

APPLICATION

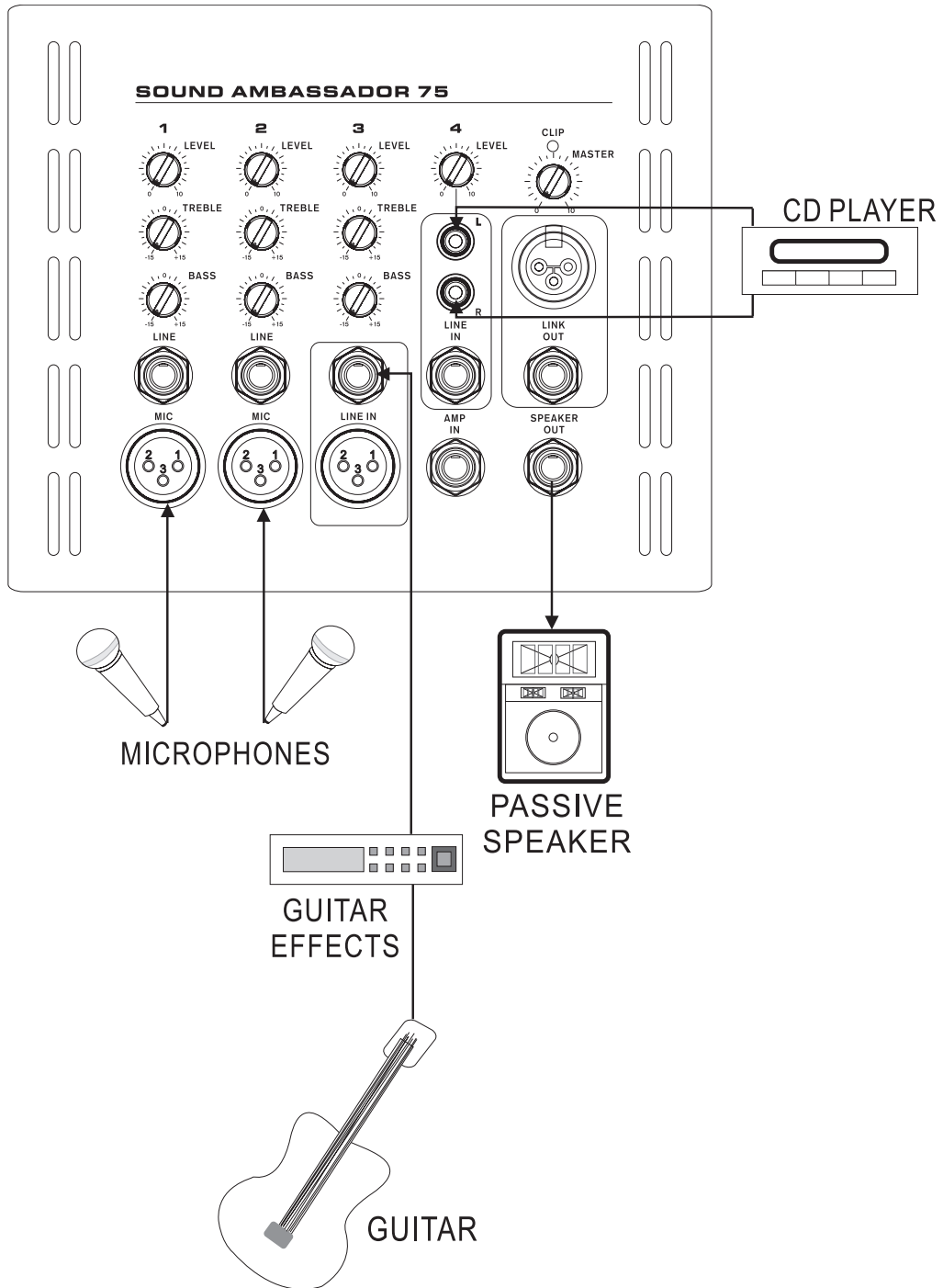

PHONIC

SPECIFICATIONS

	Sound Ambassador 75	Sound Ambassador 120
Woofer	10"	10"
Tweeter	1" compression driver	1" compression driver
Amplifier (watts), RMS	75 Watt @ 8 ohms; 115 Watt @4 ohms	120 Watt @ 8 ohms; 185 Watt @4 ohms
Mixer	2 mic and 4 line inputs	2 mic and 4 line inputs
Channel Tone control		
Treble	+/- 15dB @10k Hz	+/- 15dB @10k Hz
Bass	+/- 15dB @ 80Hz	+/- 15dB @ 80Hz
Frequency response (-10dB point)	50Hz~20KHz	50Hz~20KHz
Indicator		
Peak LED	Red	Red
Power LED	Blue	Blue
Appearance		
Handle	on top	on top
Flying points	2	2
Mount standable	35mm tripod stand socket	35mm tripod stand socket
Stackable	Yes	Yes
Floor monitor version	Yes	Yes
Ceiling version	Yes, through mounting kit	Yes, through mounting kit
Wall version	Yes, through mounting kit	Yes, through mounting kit
Built-In limiter	Yes	Yes
Protection circuitry	thermal, subsonic, RF protection, Output DC offset, Power on/off muting and HF driver protection	thermal, subsonic, RF protection, Output DC offset, Power on/off muting and HF driver protection
Power Requirement	Switchable between 115VAC / 60Hz and 230VAC / 50Hz, or optional battery power	Switchable between 115VAC / 60Hz and 230VAC / 50Hz, or optional battery power
Dimensions (HxWxD)	24"x11.8"x13.8" (612x300x350 mm)	24"x11.8"x13.8" (612x300x350 mm)
Weight	29.7 lbs (13.5 kg)	34.1 lbs (15.5 kg)

DIMENSIONS

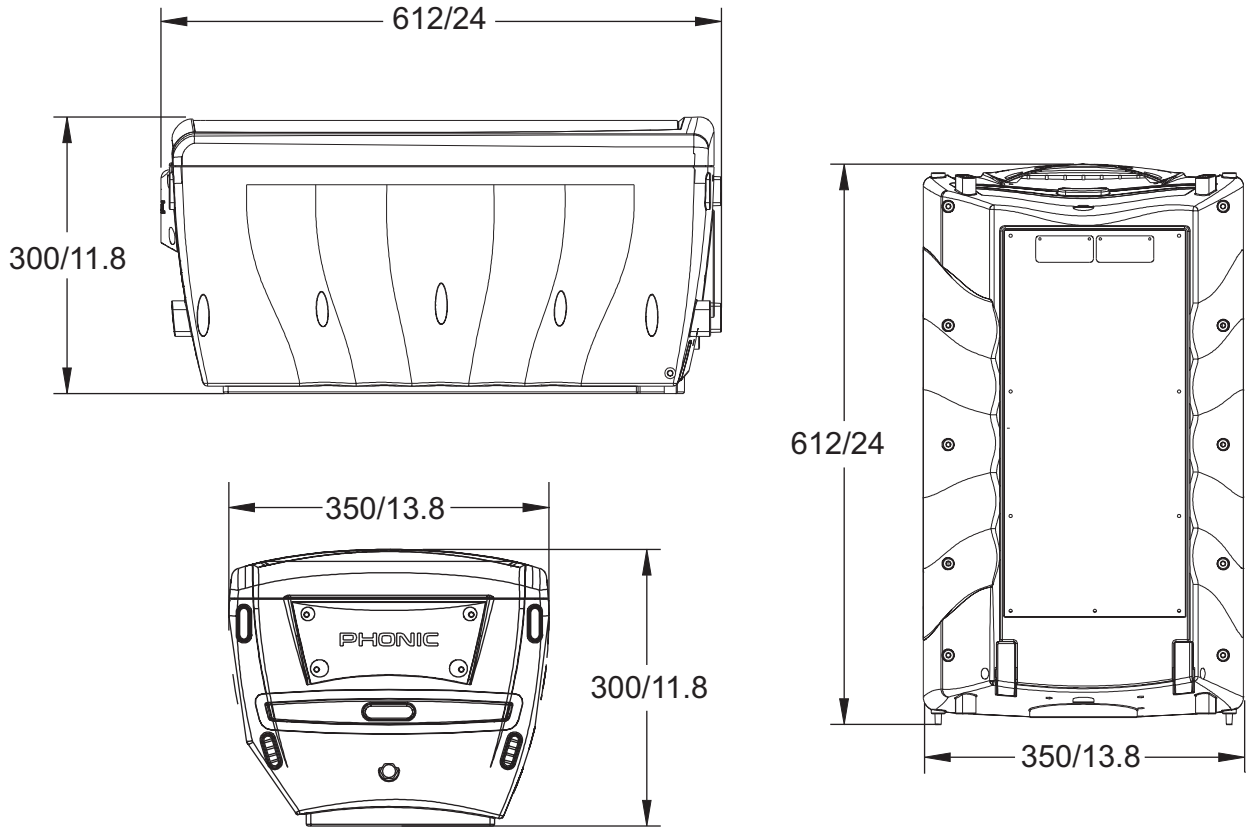

measurements are shown in mm / inches

BLOCK DIAGRAMS

Sound Ambassador 75 block

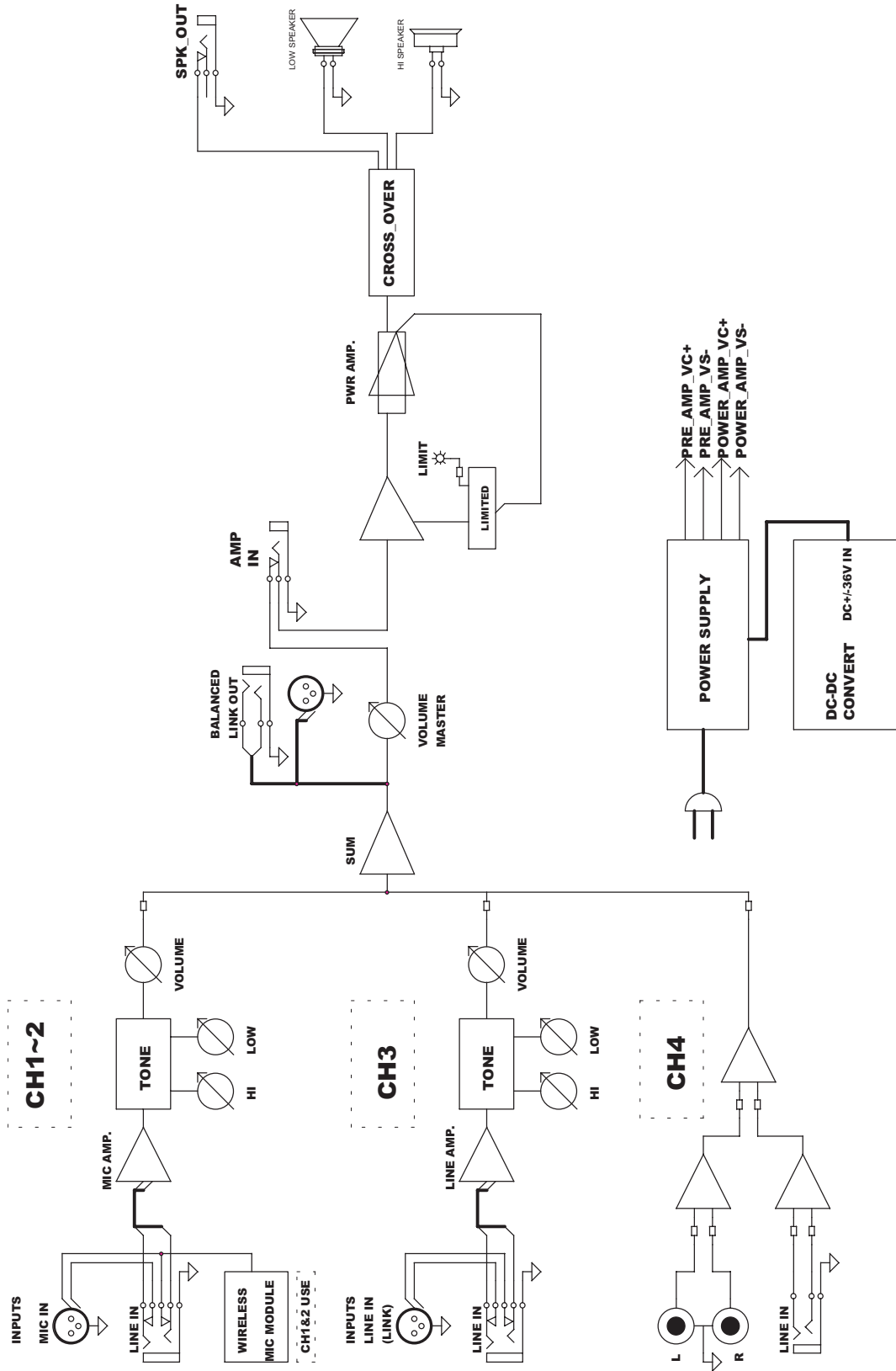

Sound Ambassador 75 block

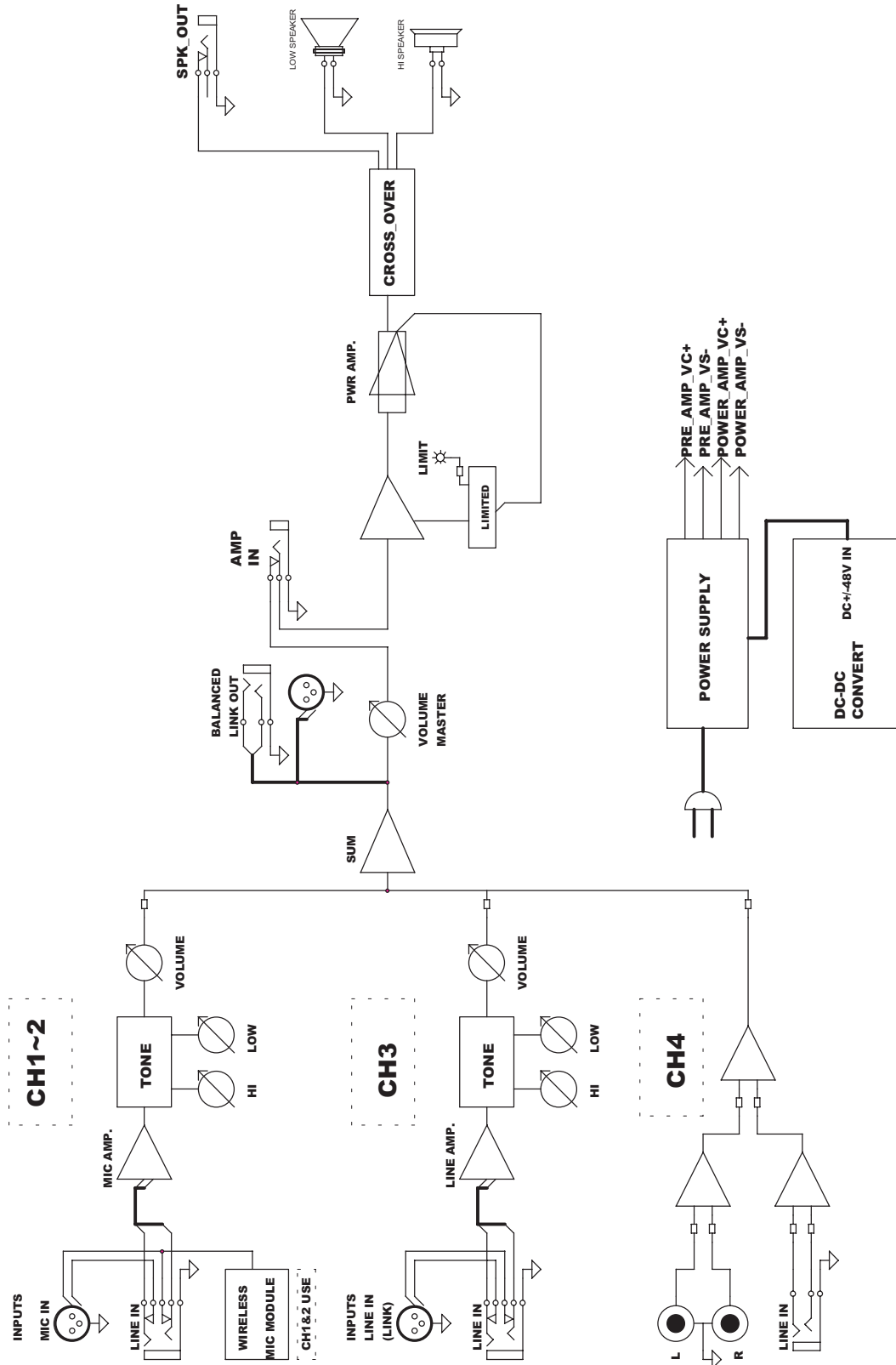

TO PURCHASE ADDITIONAL PHONIC GEAR AND ACCESSORIES

To purchase Phonic gear and optional accessories, contact any authorized Phonic distributor. For a list of Phonic distributors please visit our website at www.phonic.com and click on Get Gear. You may also contact Phonic directly and we will assist you in locating a distributor near you.

SERVICE AND REPAIR

Phonic has over 100 service centers worldwide. For replacement parts, service and repairs please contact the Phonic distributor in your country. Phonic does not release service manuals to consumers, and advice users to not attempt any self repairs, as doing so voids all warranties. You can locate a dealer near you at www.phonic.com.

WARRANTY INFORMATION

Phonic stands behind every product we make with a no-hassles warranty. Warranty coverage may be extended, depending on your region. Phonic Corporation warrants this product for a minimum of one year from the original date of purchase against defects in material and workmanship under use as instructed by the user's manual. Phonic, at its option, shall repair or replace the defective unit covered by this warranty. Please retain the dated sales receipt as evidence of the date of purchase. You will need it for any warranty service. No returns or repairs will be accepted without a proper RMA number (return merchandise authorization). In order to keep this warranty in effect, the product must have been handled and used as prescribed in the instructions accompanying this warranty. Any tempering of the product or attempts of self repair voids all warranty. This warranty does not cover any damage due to accident, misuse, abuse, or negligence. This warranty is valid only if the product was purchased new from an authorized Phonic dealer/distributor. For complete warranty policy information, please visit <http://www.phonic.com>.

CUSTOMER SERVICE AND TECHNICAL SUPPORT

We encourage you to visit our online help at <http://www.phonic.com/help/>. There you can find answers to frequently asked questions, tech tips, driver downloads, returns instruction and other helpful information. We make every effort to answer your questions within one business day.

**Phonic America Corporation
6103 Johns Road #7
Tampa, FL 33634
(813) 890-8872
support@phonic.com
<http://www.phonic.com>**

PHONIC